

A revolutionary MPDP

Infinitely Expandable MPDP

MPDP

User's Manual



Thank you for purchasing our MPDP.
Please read through this user's manual for safety before installing this product.
This product is manufactured for Multi Plasma display model only.

Features of MPDP

- ▶ Enjoy a wide flat screen with high brightness and high quality.
- ▶ Easy to install and move due to its thin design
- ▶ Enjoy your favorite programs with various split-screen features simultaneously presenting several programs.

Thank you for purchasing our MPDP monitor.

This manual describes how to use the product and notes in use.
 Please read the manual carefully before using it.
 After reading this manual, please retain for future reference.
 If you have any questions or a problem occurs, please contact either the company you purchased this product from or an authorized service center.

※ **Displaying static picture for an extended period of time may cause an afterimage effect.**



Warning If you fail to comply with the regulations for safety and proper use, fire or injury may be caused.

Notice to users

Class A digital device

It is a device designed for business purpose with a safety certificate for electromagnetic interference, which user should be mindful of.

Supplied Accessories

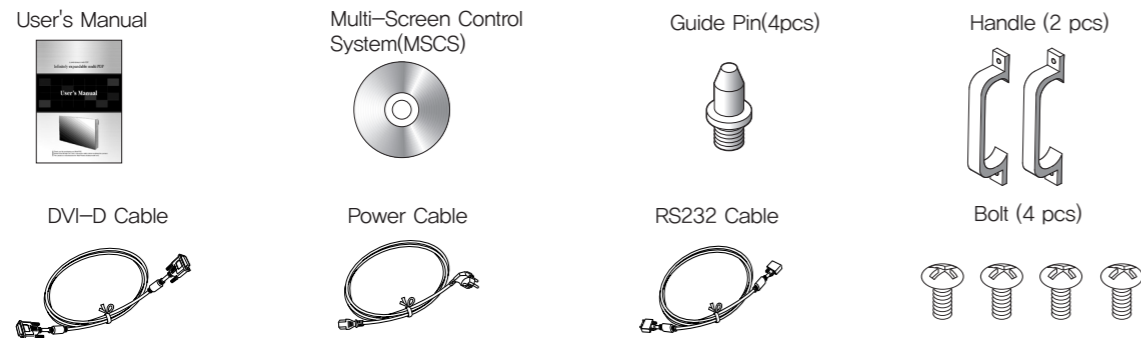

Optional Accessories

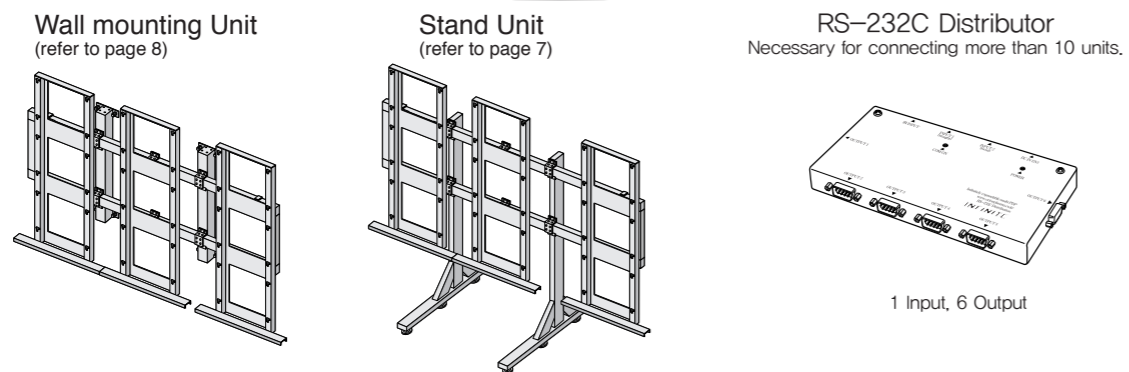

Contents

1. Safety Precautions.....	3
2. How to Install.....	5
3. Guidance for Users.....	9
4. How to Connect Cables.....	11
4.1. Connection of one set MPDP.....	11
PC & DVI Connection.....	11
VCR Connection.....	13
DVD Player & DTV Set top box connection.....	15
4.2. Connection of Multi-screen MPDP.....	17
4.3. Connection of RS-232C Cable.....	19
4.4. Connection of 3 x 3 MPDP.....	20
4.5. ID setting of X x Y MPDP.....	21
5. Setting and operation of MSCS.....	22
5.1. Setting 'Com Port'.....	23
5.2. "Last design/New design" setting.....	23
5.3. Setting 'Multi-Screen' Configuration.....	24
5.4. MSCS Instruction.....	25
5.5. ID Setting.....	25
5.6. Configuration of various modes.....	26
5.7. Setting multi screens at a time.....	27
5.8. Slide Control.....	28
5.9. MSCS Size Control.....	30
5.10. PDP Control.....	31
5.11. Screen control.....	32
5.12. Auto Tracking.....	33
5.13. Setting "Timer On/Off".....	34
5.14. Broadcast On.....	35
5.15. Orion PDP Home Page logon and Version information.....	36
6. MSCS Protocol.....	37
7. Other tips.....	41
7.1. Before calling for service.....	41
7.2. About Plasma display panel.....	42
8. Resolution of PC video signal.....	43
8.1. DVD / DTV.....	43
8.2. PC & DVI.....	43
9. Specifications.....	44

1. Safety Precautions

- If it operates abnormally, stop using it immediately.

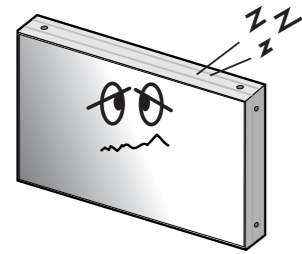

- Do not place any liquid-containing container on it. If the inside is wet, it may cause electric shock or fire.

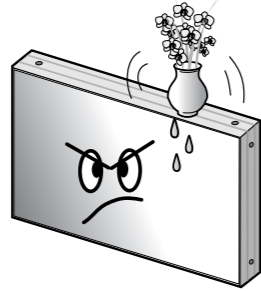

- Do not put any foreign material into the product. It may cause a failure or shorten the life span.

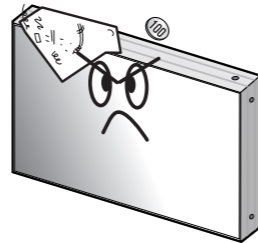

- Please refer to a specialized construction company for installing stand or wall mount unit. Otherwise, damage or injury may be caused.



- Do not touch the device when lightning strikes.

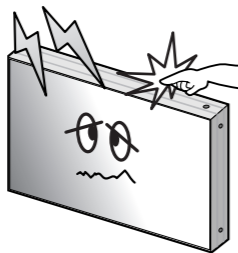

- Do not install in an unstable location. It may cause injury.

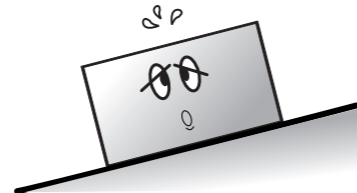

- Avoid any action to damage the power cord or power plug. It may cause fire or electric shock.

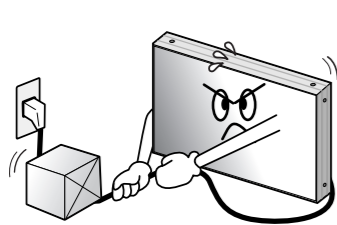

- Do not pull out the power plug with a wet hand. It may cause electric shock.



- Do not exceed ratings of AC outlet or extension cords. It may cause failure.

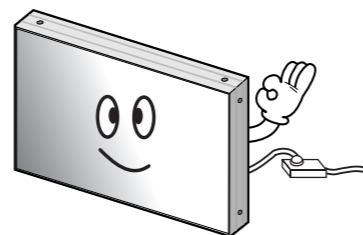

- Do not alter (or disassemble) the product. It may cause electric shock since high voltage is flowing inside.

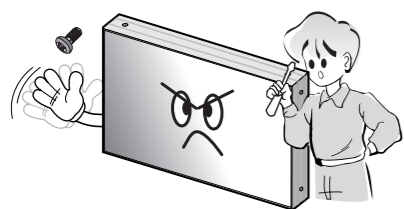

- Do not install the product where it may be exposed to direct sunlight or near any heating device. It may shorten the product's life span or cause failure.

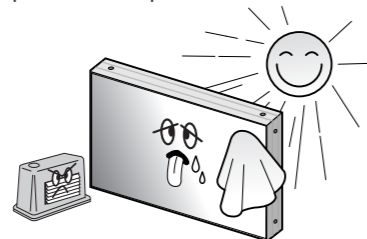

- Make sure the product is not covered with any object. If the ventilation hole is blocked, the inside temperature may rise to cause overheating resulting in fire.

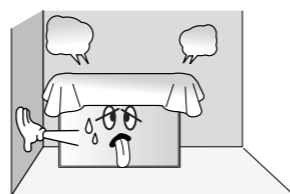

- Do not pull out or hang down the connection cable. It may damage the cord to cause fire or electric shock.

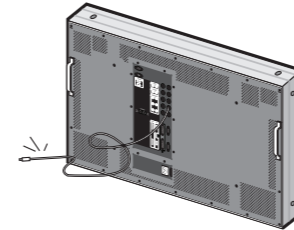

- Do not lean against the product or keep it leaned. It may cause injury or failure.

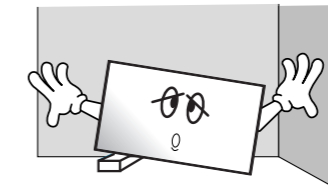

- Do not put it at any place with much humidity, dust, oil, smoke or steam. It may cause failure.

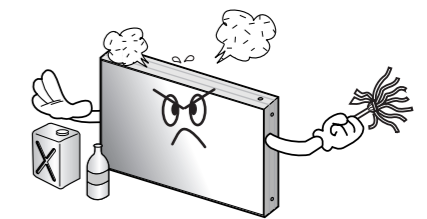

- Pull out the power plug by holding the plug. Otherwise, it may damage the power cord to cause fire or electric shock.

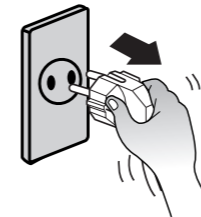

- If you do not want to use the product for a long time, keep the power plug unplugged to save electricity.
- The socket-outlet should be installed near the equipment and be easily accessible.

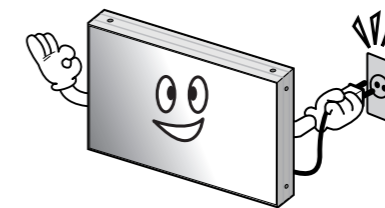

- Do not put any heavy object on it. It may cause failure.

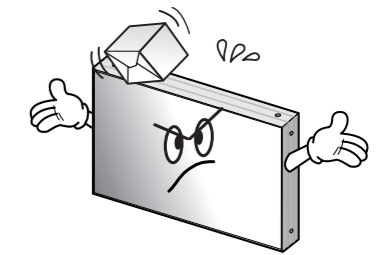

- Install the product on safe and flat surface.

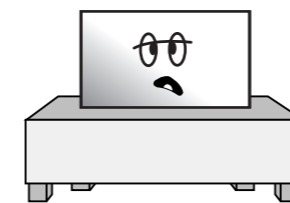

- Do not ride or step on the product. It may cause breakage when fallen down.

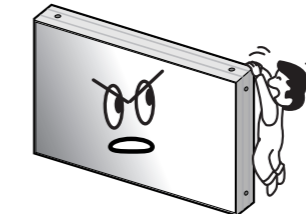

- When moving it, disconnect the connecting cable. Otherwise, it may damage the cable to cause fire or electric shock.

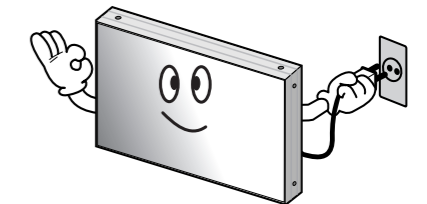

- Do not put candles on the product. If the liquid flows inside the product. It may cause electric shock or fire.

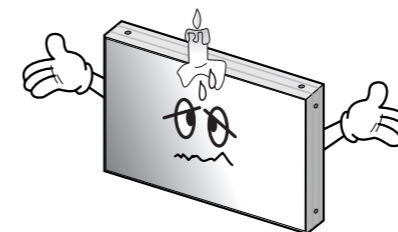

- Do not touch product's front surface with hand. Otherwise, the image quality can be lowered.

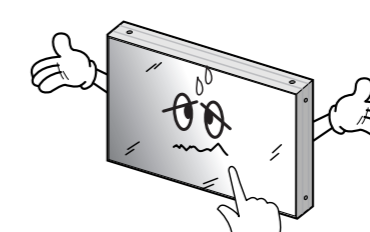

- Do not poke the front screen with sharp material. It may damage the screen and may cause malfunction of the product.

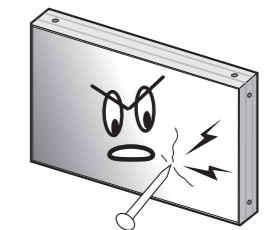

2. How to Install

- Install this set only at a location where adequate ventilation is available.

How to assemble handles

1. Product is packed in a box as shown in Figure 1.
2. Please carefully remove the Packing Bag with a knife or a pair of scissors.
※ Please check front and rear side before you cut the bag to prevent any damages on panel or set.

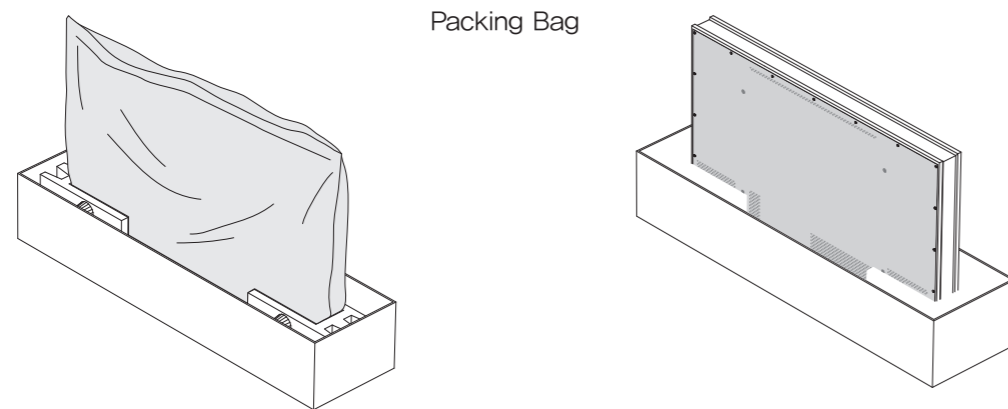

3. Please assemble handles with the bolts that are in the accessory box to the rear side as shown in the figure.

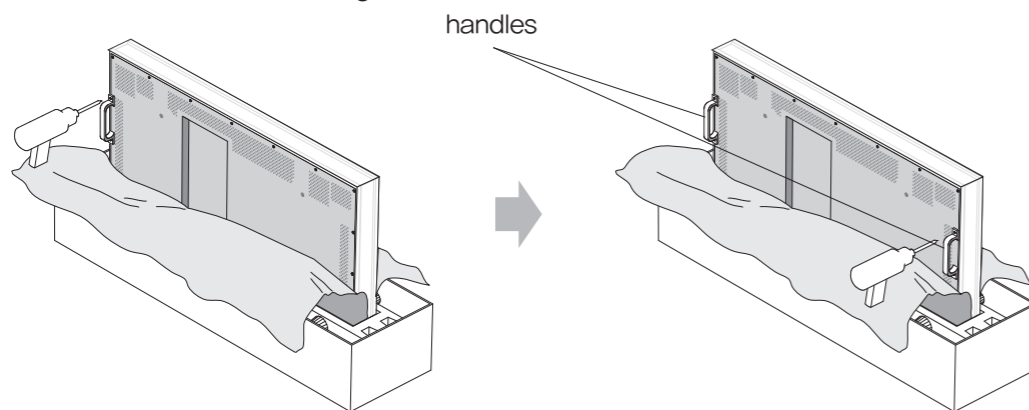

How to move MPDP

1. 2 people hold each handle on product's back side.

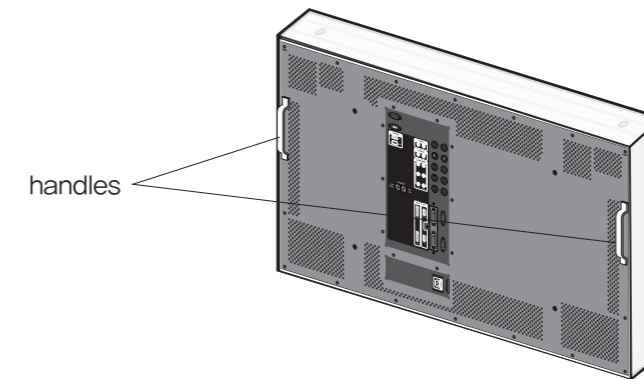

2. 2 people transfer the product with holding the handle and the front part at the same time.

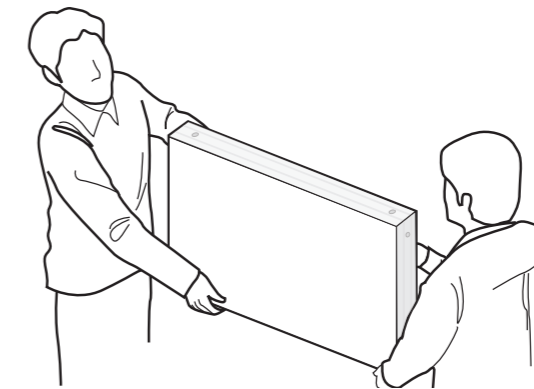

- ※Attention : Do not remove the panel protection pad until a set is completely installed on a stand or a wall hanger.
Please carefully remove Panel protection pad to prevent any damages on the product .

⚠ Attention **※ Do not incline the panel forward.**
The edge or bottom of the panel can be damaged.
When you need to lay a set down on the floor, please use shock-absorbing pads or rug beneath the set.

Stand Unit (Option)

- Please do not install our product at following locations to protect the product and prevent possible malfunction.
 - Places of vibration or shock: PDP set may fall and damaged
 - Next or near to Sprinkler sensors: The sensors may detect heat from a set and sprinkler can be activated.
 - Around high voltage power lines: Noise from the power line may affect screen images
 - Around heating apparatus: PDP set may be overheated and damaged.
- The set can be installed as shown below.
(For further information, refer to the optional 'Stand Installation and Setup Guide'.)

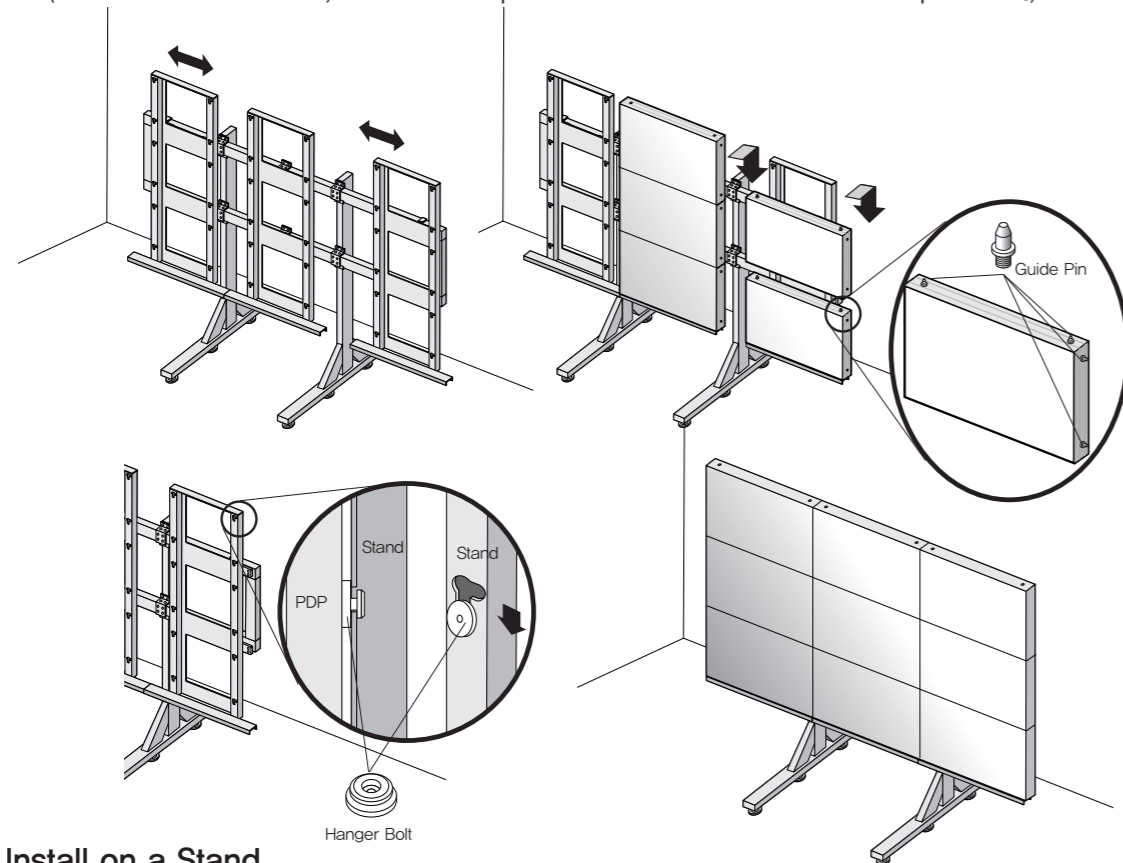

Install on a Stand

Please secure minimum clearance as shown in the picture for adequate ventilation and technical service.

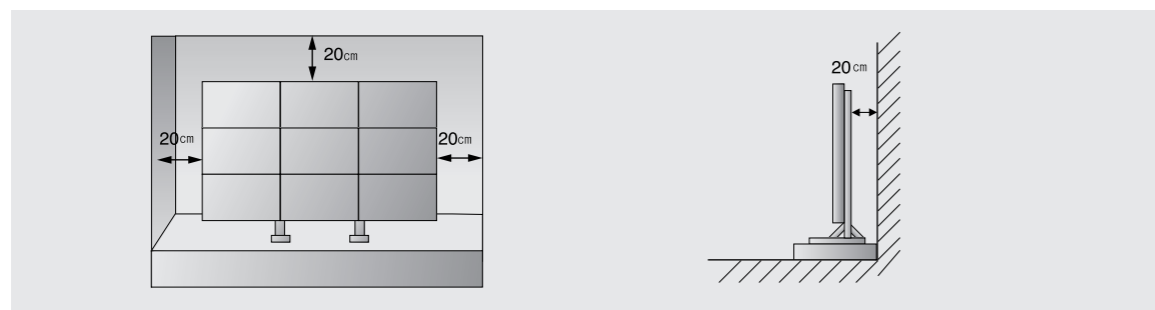

Wall Mounting Unit (Option)

- Please check the stability of wall.
If the wall is not strong enough, reinforce the wall before installation.
- Please connect all the cables to proper ports in a set before installation.
- The set can be installed on the wall as shown below.
(For further information, refer to the optional 'Wall Mounting Bracket Installation and Setup Guide'.)

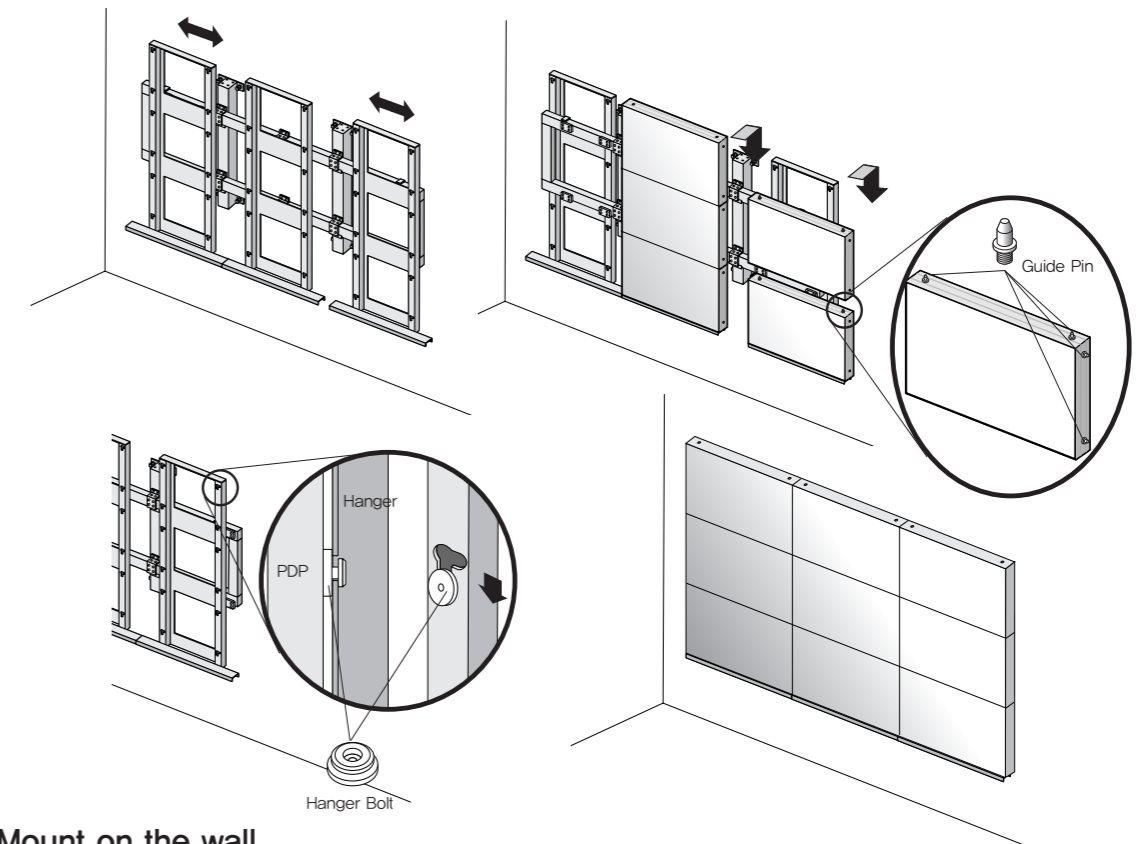

Mount on the wall

Please secure minimum clearance as shown in the picture for adequate ventilation and technical service.

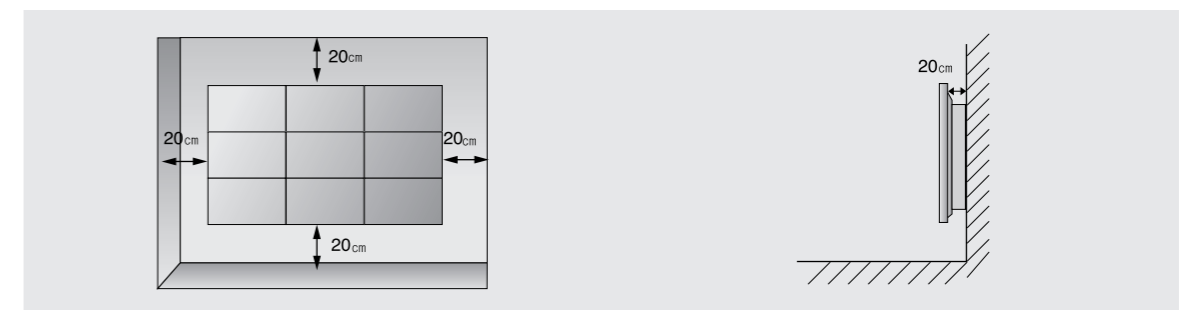

3. Guidance for Users

Input/Output Terminals

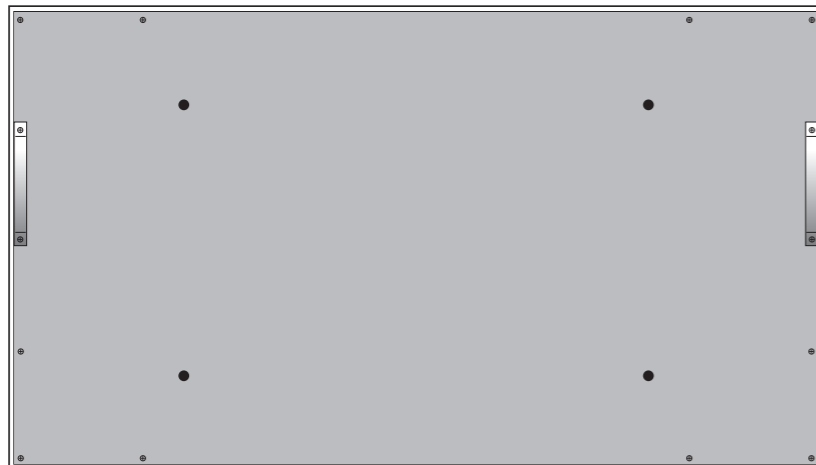

4. How to Connect Cables

4.1. Connection of one set MPDP

PC & DVI Connection

- MPDP and PC should be connected; a Com Port in a PC and RS-232C IN port in a MPDP is connected with supplied RS-232C cable.
- MPDP On/Off or Screen adjustment can be controlled by MSCS (Multi-Screen Control System).
- ID setting on the backside of MPDP must be identical with the ID setting in MSCS to control MPDP with a PC.
- If you do not have Com Port, you need to use an USB converter for RS-232. Depending on manufacturers or models, converters may cause malfunction.

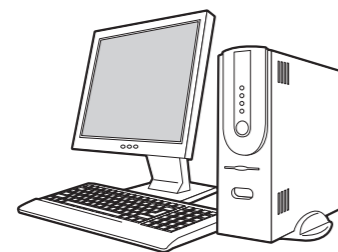

PC (MSCS) to control MPDP

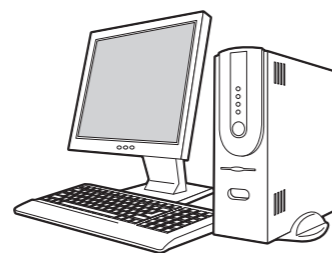

DVI connection (Maximum 5m)

※If you need longer connection, please use DVI boosters or DVI fiber-optic cable.

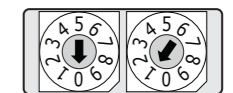
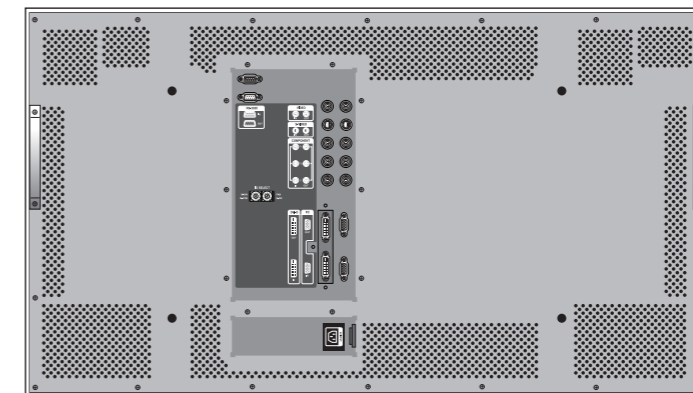

[PDP ID 1]

- ID switch must be set as ID 1 for one set use.

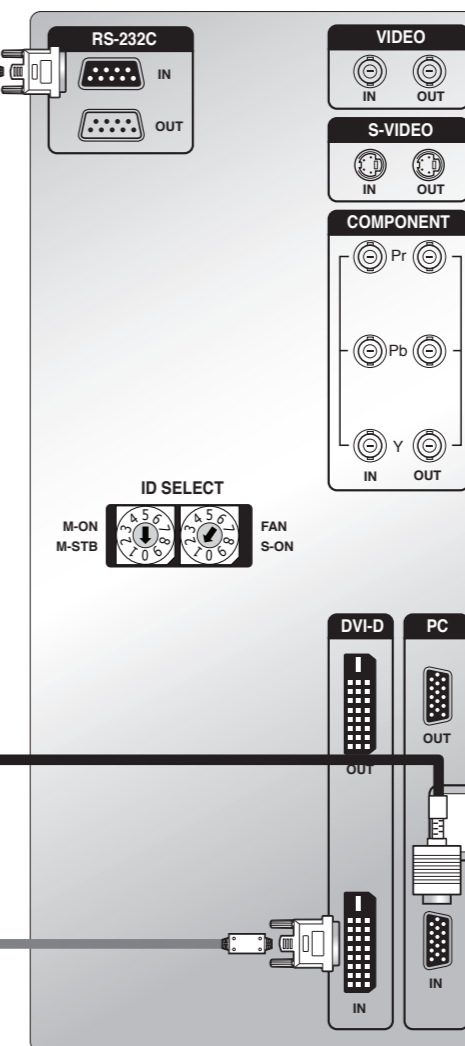

VCR Connection

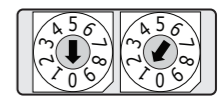
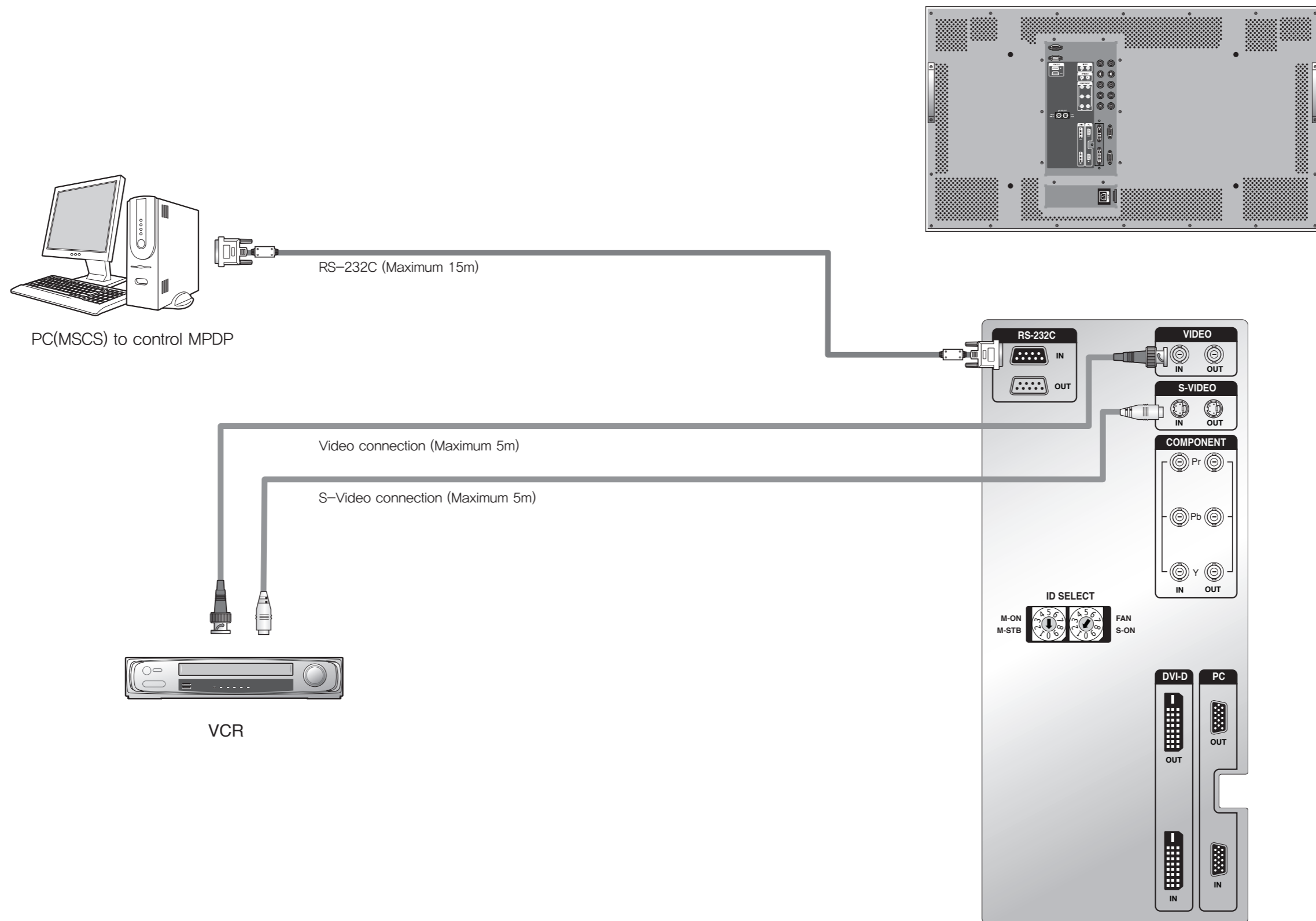

[PDP ID 1]

• ID switch must be set as ID 1 for one set use.

DVD Player & DTV Set top box connection

- In case input source is DVD, select DVD/SD in MSCS main screen.
- In case input source is DTV, select HD in MSCS main screen.

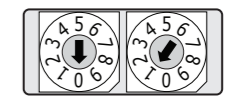
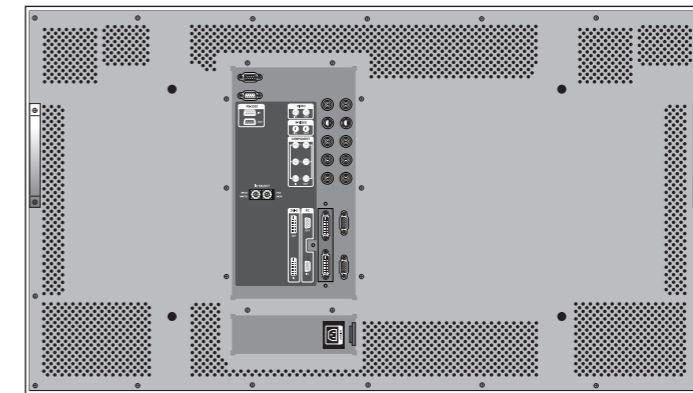
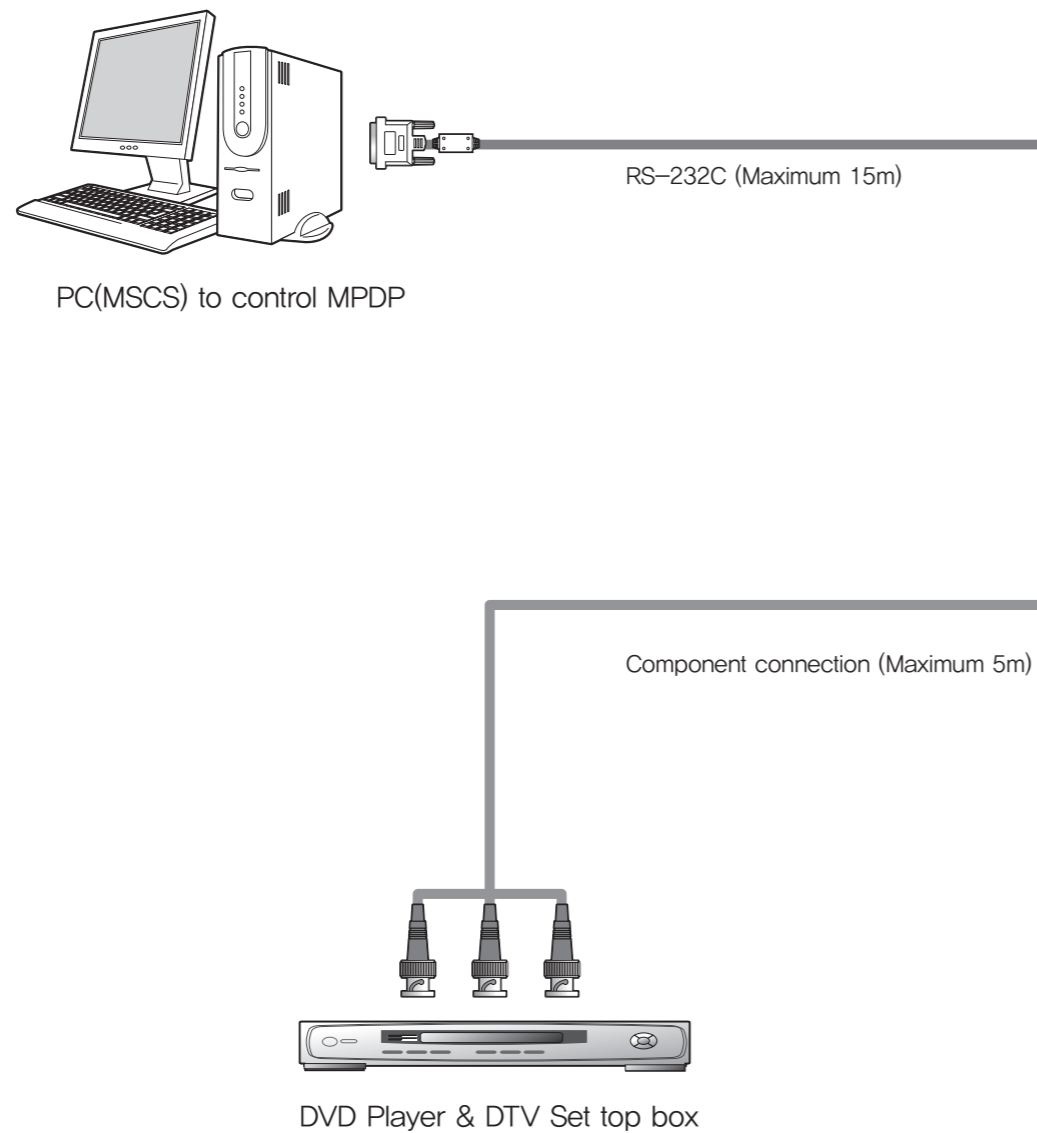

[PDP ID 1]

- ID switch must be set as ID 1 for one set use.

Component ports of the set	Y	Pb	Pr
Video output ports of DVD player	Y	Pb	Pr
	Y	B-Y	R-Y
	Y	Cb	Cr

- According to manufacturers, the indication of DVD Component output port may vary; "Y, PB, PR", "Y, B-Y, R-Y" or "Y, CB, CR."

- **Component Input ports**
You can get better image quality by connecting DVD player to component input ports as below.



- **Caution for Component connection**
In case component cables are not properly connected, you may have bluish or redish screen or even no screen images.

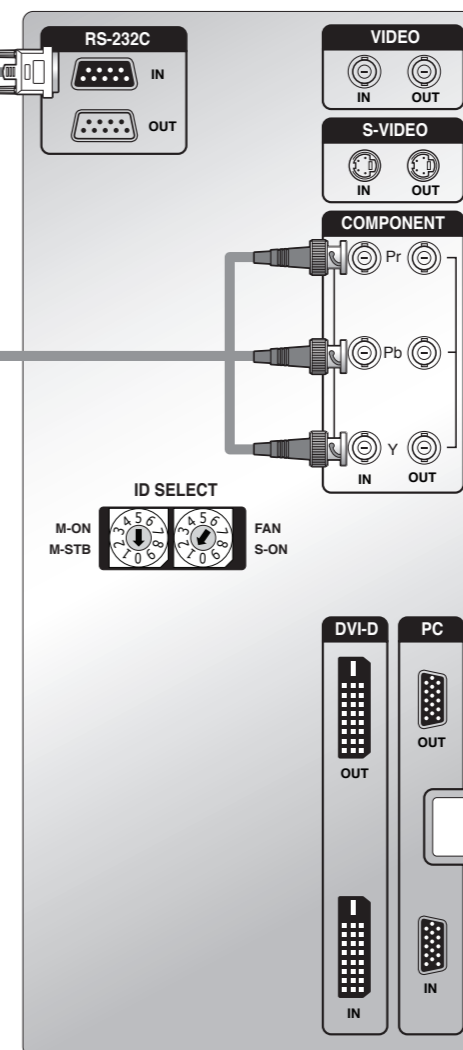

4.2. Connection of Multi-screen MPDP

- Recommended maximum set connection for Multi setting is shown in table below. If you need to connect more than described in the table, you have to use distributors.
- Image quality can be affected by cable or signal quality.

INPUT SOURCE	Resolution	Connection	Remark
DVI	1600 x 1200 x 60HZ	5 sets	
PC	8.2. PC & DVI Resolution Reference	2 sets	43 page
DTV	720p, 1080i	5 sets	
DVD	480i, 480p, 576i, 576p	6 sets	
VIDEO/S-VIDEO	NTST, PAL, SECAM	6 sets	

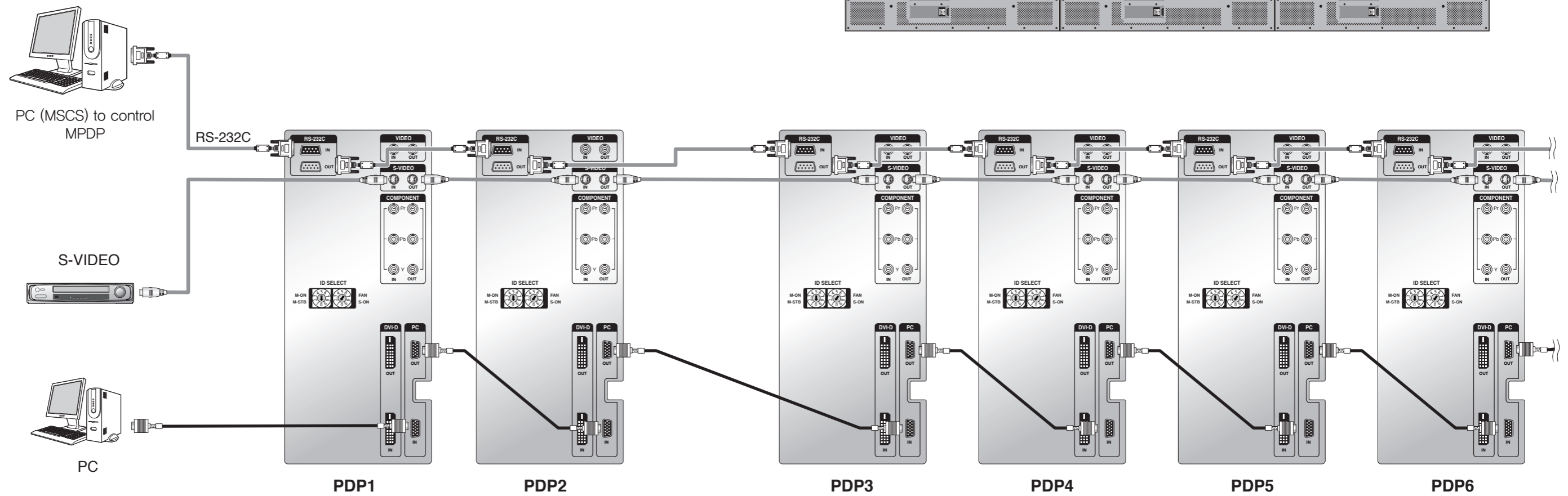
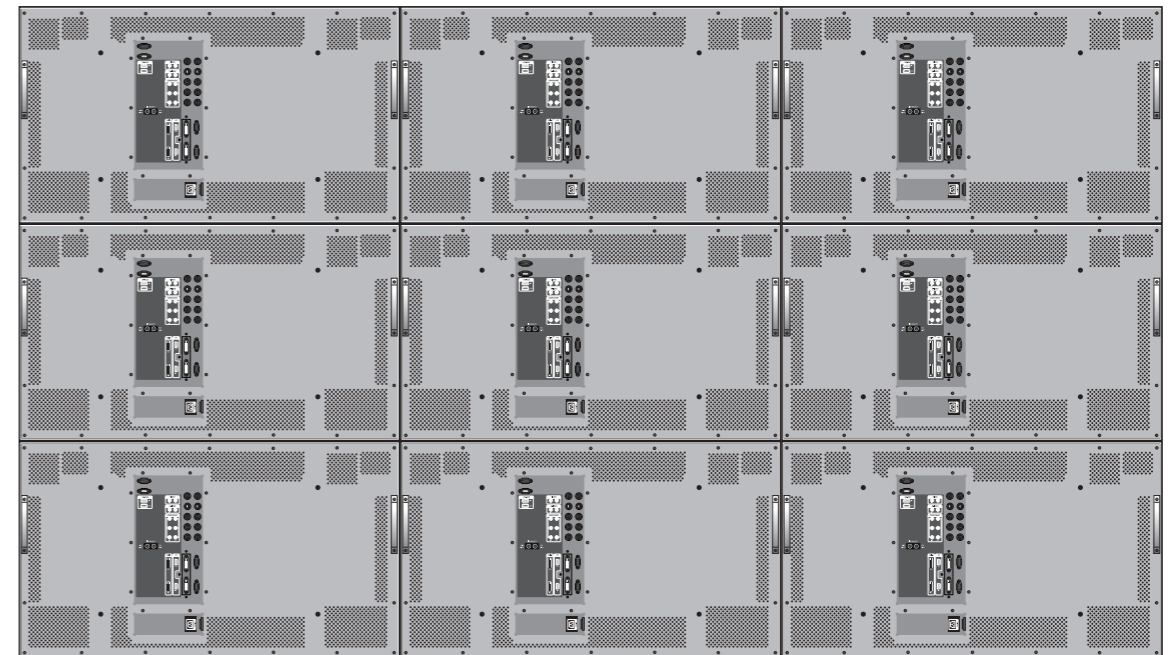

4.3. Connection of RS-232C Cable

- Maximum use of RS-232 with Daisy Chain connection is **10** or less.
If you need additional connection, use RS-232 distributor.

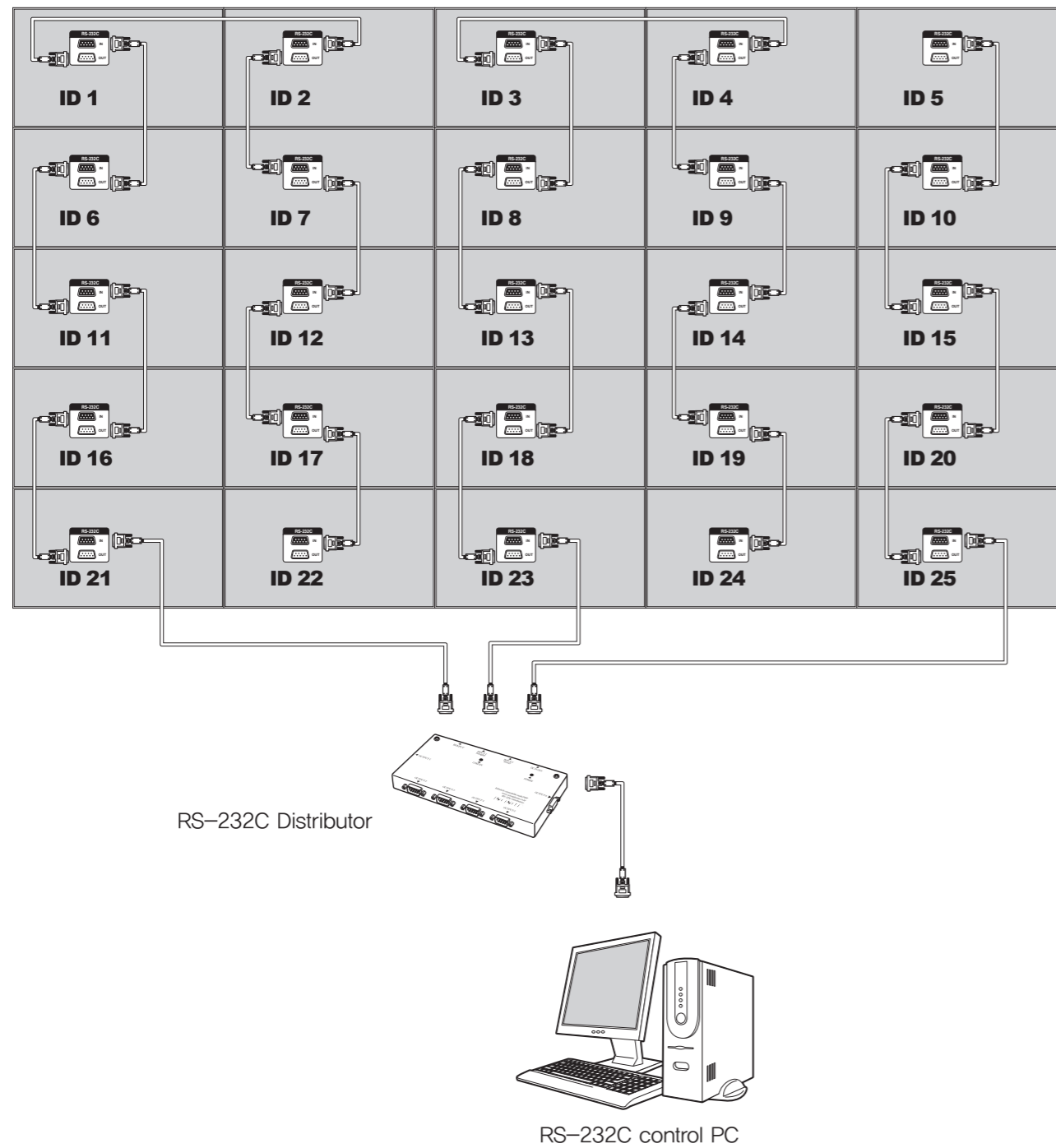

4.4. Connection of 3 x 3 MPDP

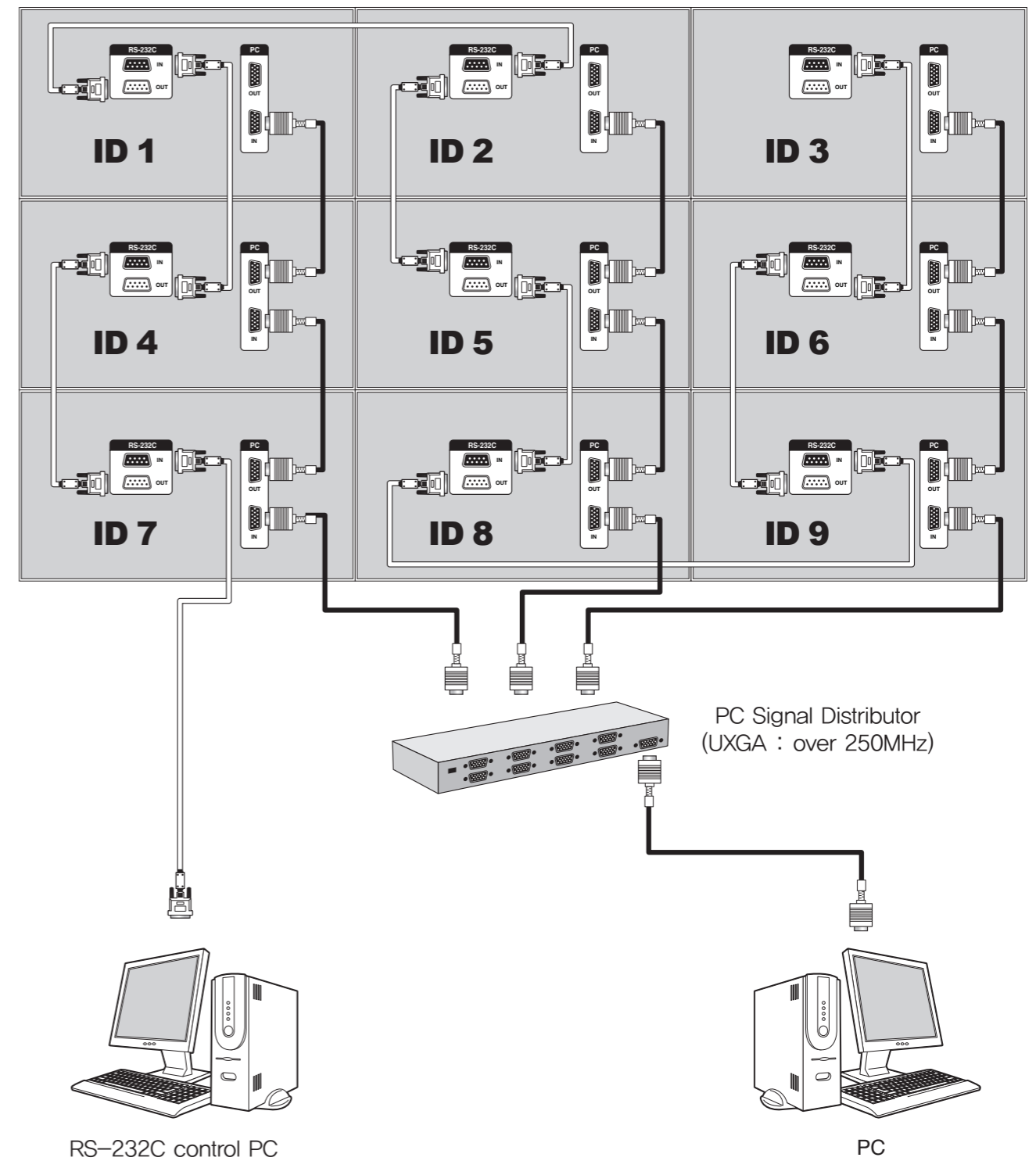

4.5. ID setting of X x Y MPDP

- Identity number (ID) indicates the location of each MPDP.
- When you look at the MPDP screens in front of MPDP.

PDP ID 1	PDP ID 2	PDP ID 3	PDP ID 4	PDP ID 5
PDP ID 6	PDP ID 7	PDP ID 8	PDP ID 9	PDP ID 10
PDP ID 11	PDP ID 12	PDP ID 13	PDP ID 14	PDP ID 15
PDP ID 16	PDP ID 17	PDP ID 18	PDP ID 19	PDP ID 20
PDP ID 21	PDP ID 22	PDP ID 23	PDP ID 24	PDP ID 25

Recommended ID of X x Y screens

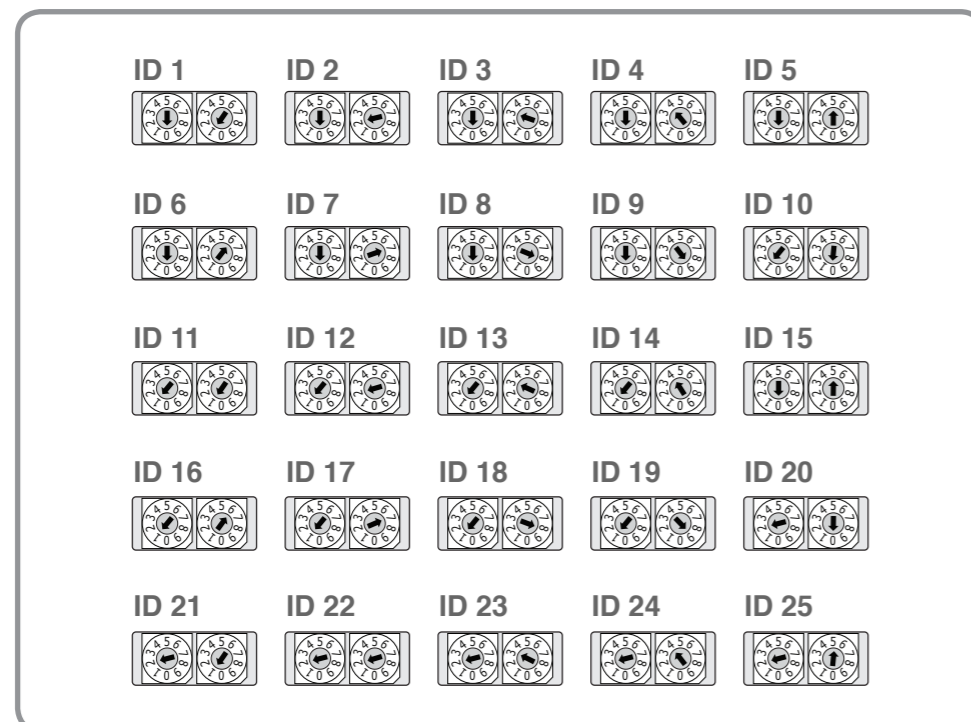

5. Setting and operation of MSCS

- MSCS is an application program needed to control MPDP.
- Activate MSCS setup file. Directory is created in C: \Program file \MSCS(v3.0) and shortcut is made on the monitor.
- Activate MSCS(v3.0).exe file
Main image of MSCS is as shown below.

• MSCS supports Windows XP® and Windows 2000® only.

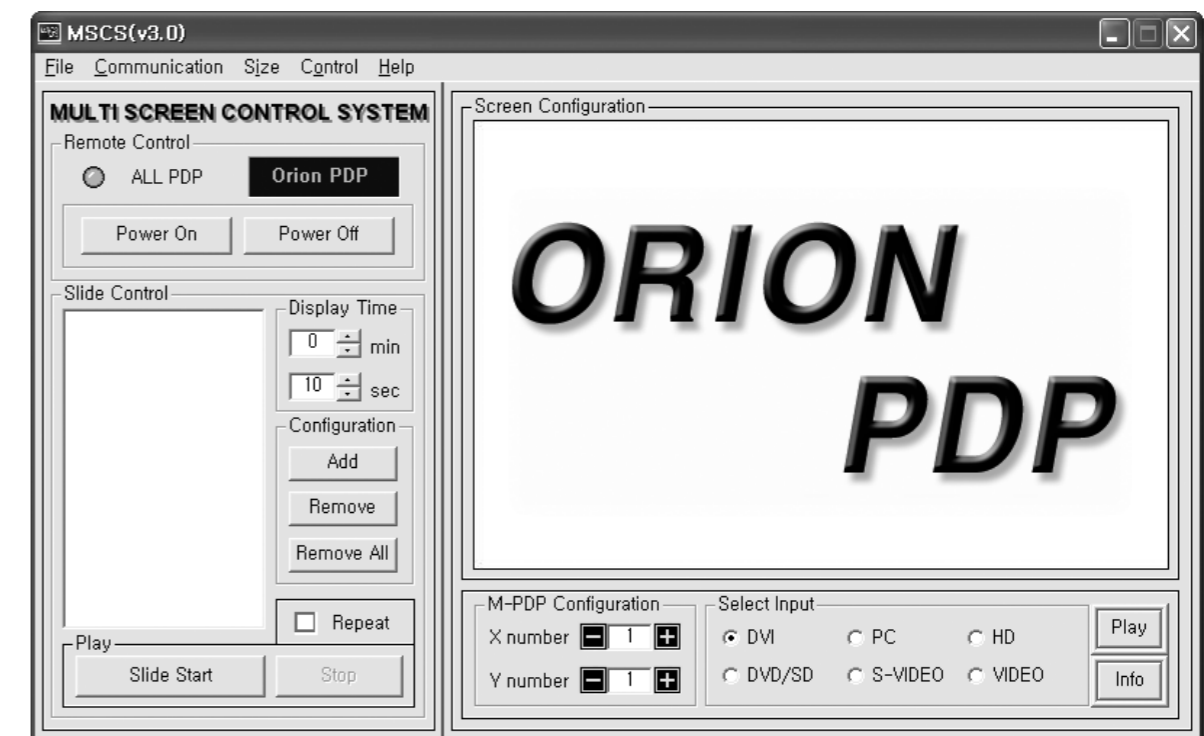

Main Image of MSCS (Multi Screen Control system)

5.1. Setting 'Com Port'

- Com Port connects or disconnects the communication between PC and MPDP.
- Connect MPDP to PC Com Port via RS-232C cable.

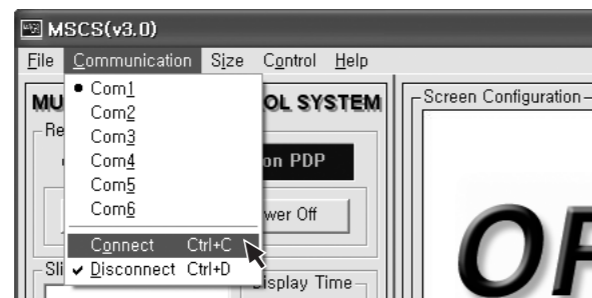

Communication Setting

- Go to MSCS Menu → Communication and set Com Port. Click 'Connect' using mouse or press 'Ctrl+C' using keyboard.
- In order to disconnect communication, click 'Disconnect' using mouse or press 'Ctrl+D' using keyboard.
- When you use USB-to-RS232C converters, you need to set Com Port again, because MSCS uses one of Com Port no. 1 to 6.

5.2. "Last design/New design" setting

When Com Port is successfully connected, pop-up window for "Last design/New design" appears.



Last/New Design Set

- Click "Open Last Design" to go to latest design before closing.
- Click "Open New Design" to prepare new configuration.

5.3. Setting 'Multi-Screen' Configuration

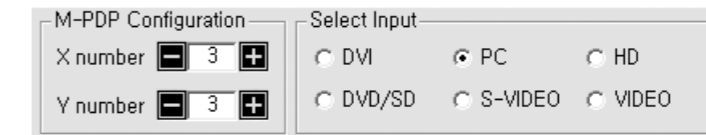

Screen Configuration Setting

- 1 Select a desirable X number and Y number**
 - X number represents the number of MPDP columns and Y number represents the number of MPDP rows.
 - The range of X and Y is 1 to 9.
- 2 Select one of input sources from DVI, PC, HD, DVD/SD, S-VIDEO, or VIDEO.**
- 3 Press "play" button**
 - Click "PLAY" button after selecting input source and the number of X and Y, then selected screen configuration is displayed as MPDP like following figure below.

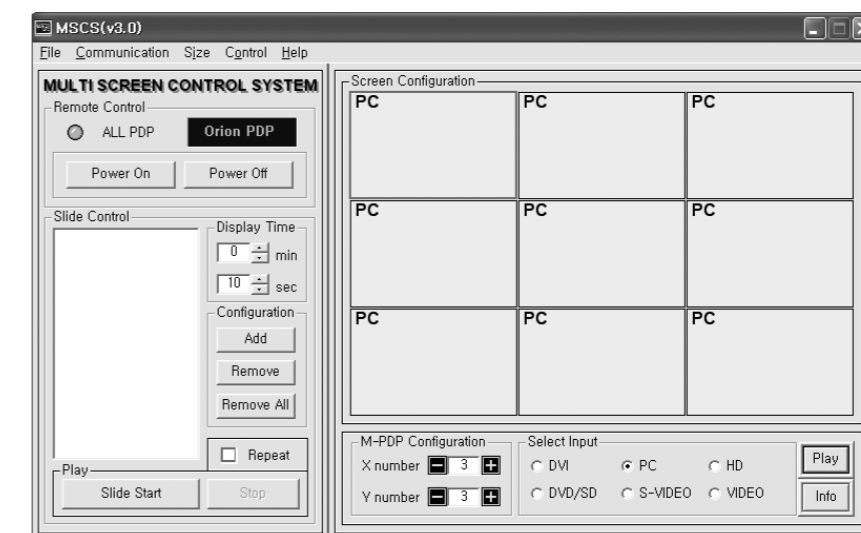

– Info: you can check selected resolution, It is displayed lower right corner of the product.

5.4. MSCS Instruction

- Check "ALL PDP" to send data to all connected MPDP regardless of ID.

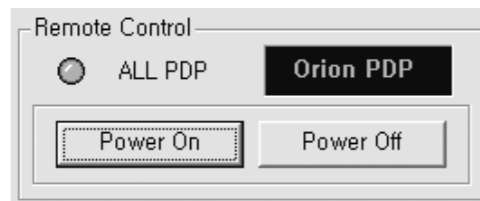

MPDP Control – Power On/Off

- In order to control power of specific MPDP, use "Power On/Off" button after selecting the specific MPDP.



Caution

Please wait for about 10 seconds after connecting power plug to MPDP or it may not work properly. In case MPDP does not work properly, please pull out the power plug and reconnect the plug.

5.5. ID Setting

- ID of MSCS(Multi Screen Control System) is set automatically.

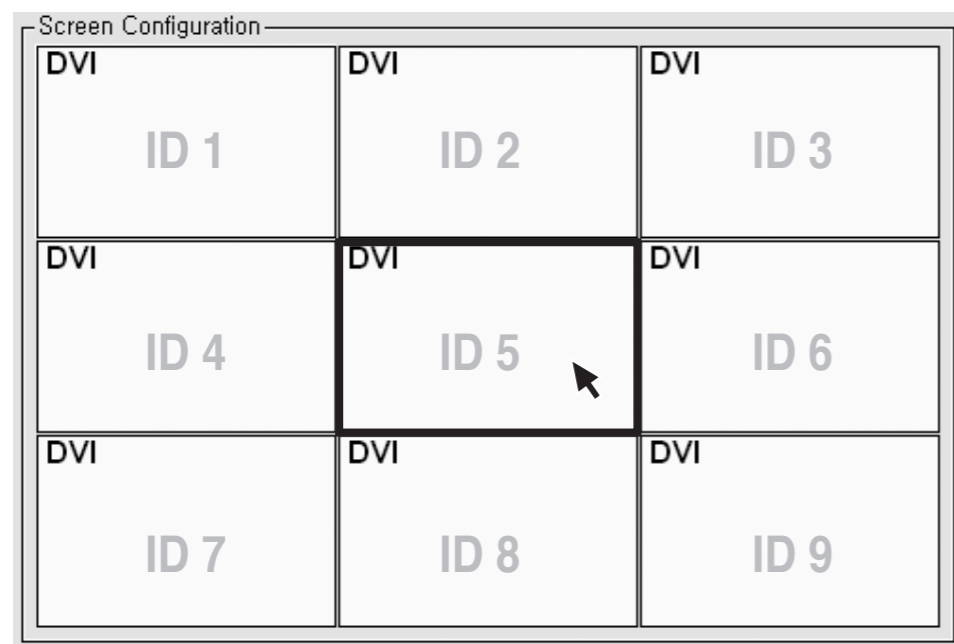

Example of MPDP ID Setting
(Input signal is DVI, Configuration is 3 by 3)

- In order to transmit data to chosen MPDP, ID of Screen Configuration must be selected.
- Select ID using right button of mouse. Selected ID is displayed with red square box.

5.6. Configuration of various modes

- You can configure various input sources as you want.

1 Select a desirable input Source in "Select Input"

- Ex) Select "DVI" in "Select Input"

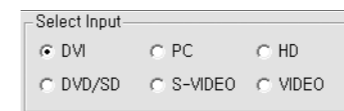

2 Click desirable screen with left button of mouse then the screen would be converted into DVI.

- Click the left mouse button on the screen that you want to change. Screen will be turned into DVI input screen.



3 You can configure other screens in the same way.

- Selected screen would be converted into DVD.

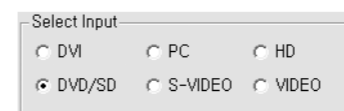

5.7. Setting multi screens at a time

- You can select multi screens at a time as you want.

- 1 Select a desirable input source in "Select Input"
 - Select "DVI" in "Select Input".

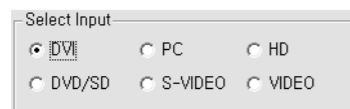

- 2 Select screens with left button of mouse and drag from the first screen.

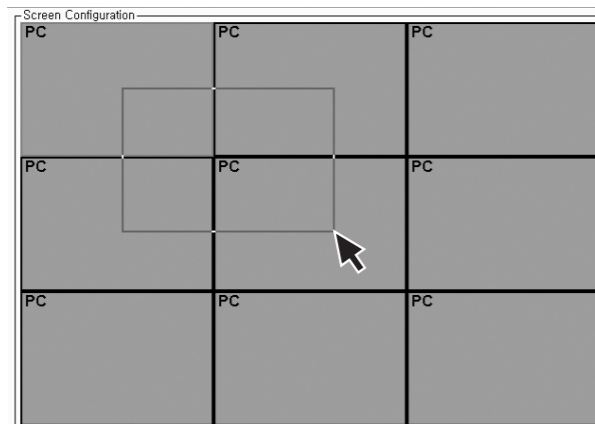

- 3 Selected screens would be converted into DVI.



※Click 'Play' button on the main image of MSCS or scroll using mouse to return to initial image.

5.8. Slide Control

- MPDP configuration that users set is displaying repeatedly.

- 1 Make a desirable configuration in "Screen Configurations"

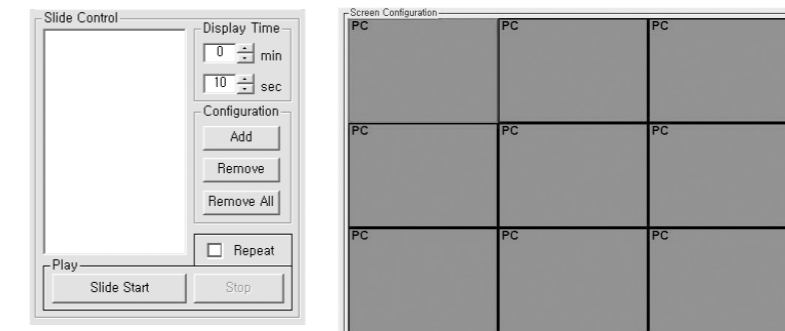

- 2 Set "Display Time" in "Slide Control"

- Click "Add" button to save configuration.
- The range of "Display Time" is from 10 seconds to 1 hour.

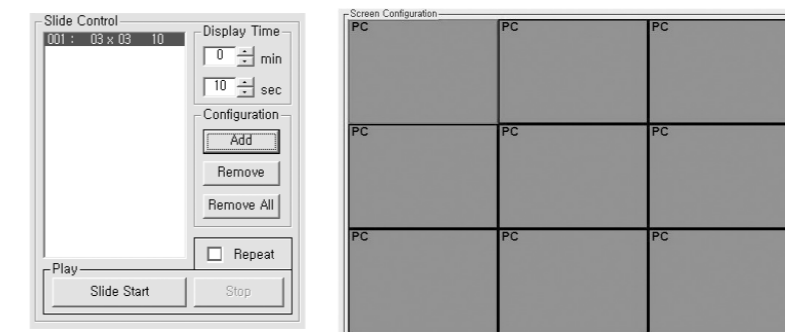

- 3 Save various screen configurations in the same way.

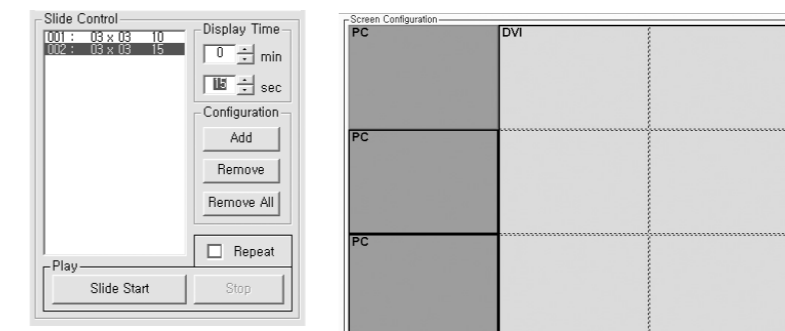

- 4** Click "Slide Start" to display saved screen configurations.
 –Saved screen configurations are displaying for preset time.

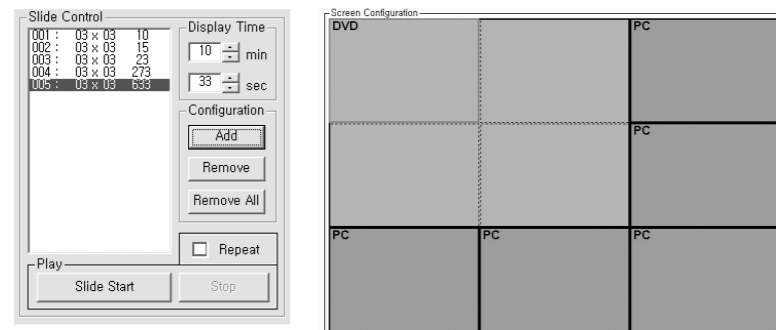

- 5** Check "Repeat" to display saved configuration repeatedly.

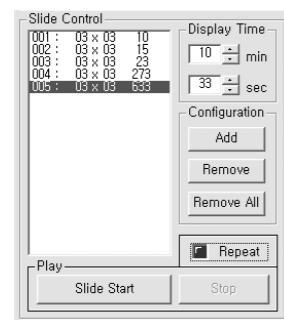

- 6** Click "Stop" button to end "Slide Control"

※To view the slide form, click 'List Box' of saved slide.
 ※To transmit saved slide protocol command, double click 'List Box' of saved slide.

5.9. MSCS Size Control

- The window size of MSCS can be set in three levels of small, medium and large as indicated below.
- You can select proper size based on the resolution of user's PC.

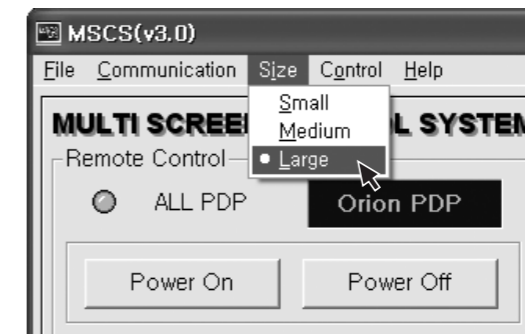

5.10. PDP Control

- Select "PDP Control" from "Control" in the Menu bar.

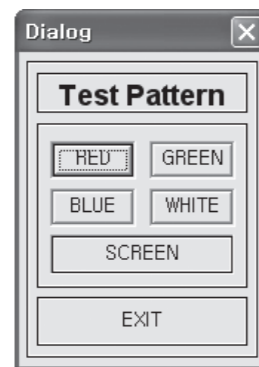

PDP Control Pattern Control

- To control MPDP Test pattern, select "Red", "Green", "Blue" or "White" buttons from "Pattern Control" in the "PDP Control".
- To return previous user configuration from "Pattern Control", you have to click "SCREEN" → "EXIT" to finish "PDP Control"

5.11. Screen control

- Register values related to display of MPDP can be changed.
- Click "Picture Control" of "Control" menu bar or enter "Ctrl+W" in order to run "Picture Control" window.

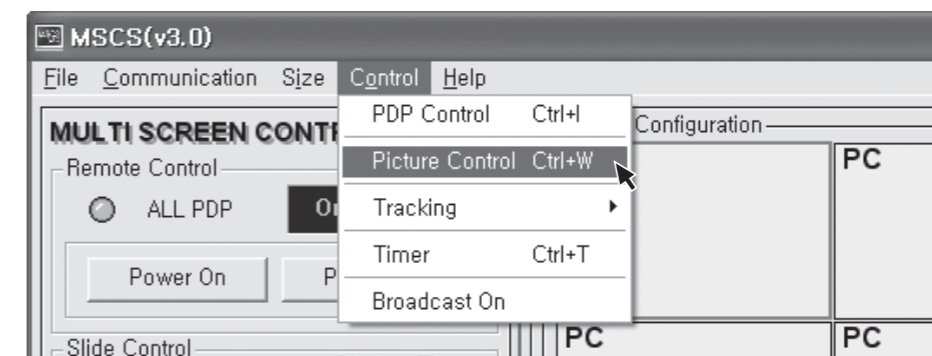

Picture Control

- In order to control display values, input values directly in "Edit Box" and press Enter key. Or click -/+ button using mouse.
- Check "All PDP" to transmit command data to all connected MPDPs regardless of ID.
- Click "Exit" button or press "Ctrl+X" using keyboard to close "Picture Control" window.
- Auto Power Mode
 - Click "Auto On" in Auto Power Mode menu.
 - When you reconnect power cable, MPDP is turned on automatically.

5.12. Auto Tracking

- Alignment adjustment is available when input source is PC.

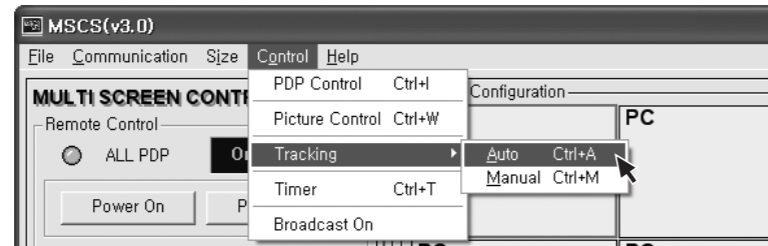

- Go to "Control" in menu bar → Tracking → Auto in order to run "Tracking Auto" window.



Tracking Manual Window

- In case alignment doesn't work through "Tracking Auto" command, users can tune finely through "Tracking Manual". Go to "Control" of menu bar → Tracking → Manual or press "Ctrl+M" using keyboard.
- "Tracking Manual" window enables users to set Frequency, Phase, LineStart and PixelStart.
- When "Tracking Manual" window is on display, users cannot display "Picture Control" window.
- Even when "Tracking Manual" window is on display, selecting 'ID' is available by clicking right button of mouse. (Refer to "5.5 PDP ID Setting".)

- Detail adjustment steps are as follows.

- 1) Tune "Phase" until the vertical lines are clearly adjusted..
- 2) Tune "LineStart" to adjust vertical alignment. "PixelStart" for horizontal alignment.
- 3) Adjust "Frequency" if alignment is still wrong.
If you adjust "Frequency", repeat step 1) and 2) to fit alignment.
Adjustable range is as follows
 - The range of "Frequency" you can adjust is -50 to 50
 - The range of "Phase" you can adjust is 0 to 31
 - The range of "Linestart" you can adjust is -23 to 10
 - The range of "Pixelstart" you can adjust is -50 to 40

- Check "All PDP" button to transmit tracking command data to all connected MPDPs regardless of ID.
- Click "Exit" button or press "Ctrl+X" using keyboard to close "Tracking Manual" window.

5.13. Setting "Timer On/Off"

- MPDP turns on and off through designated time schedule set by users.
- In order to activate timer window, go to Control menu bar → Timer or enter "Ctrl+T" using keyboard.

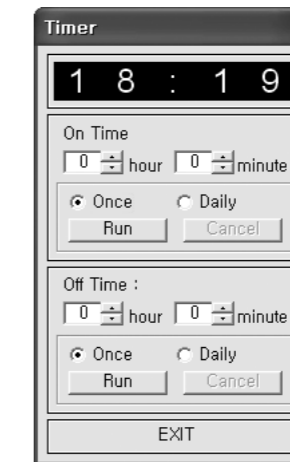
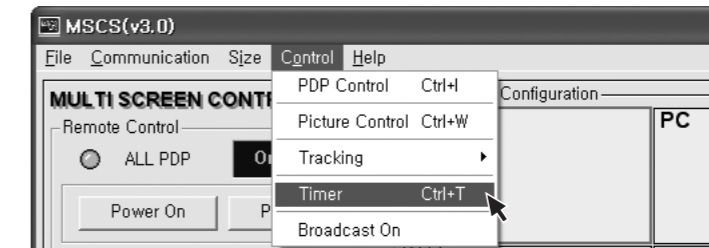

Timer

- Follow as described below to control "On Time" or "Off Time".
 - 1) Set hour and minute in "On Time".
 - 2) Check "Once" for only one time running and check "Daily" for daily running of "On Time" function.
- Follow "On Time" to control "Off Time" function.
- "Timer On/Off" function lasts even though the "Timer" window is closed.
- Users can not set same time in "On Time" and "Off Time".
- Timer function does not work when MSCS is Off or disconnected.

5.14. Broadcast On

- All the connected MPDP sets are turned on at the same time by clicking "Power On" after selecting "Broadcast On".
- Go to Menu → Control → Broadcast On.

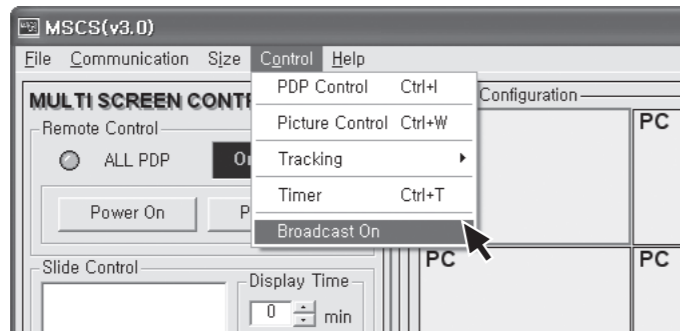

Broadcast On

5.15. Orion PDP Home Page logon and Version information

- In order to move to Orion PDP's website, go to "Help" of menu bar → "Orion PDP Home Page".

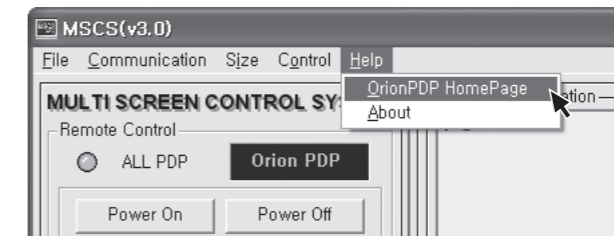

Orion PDP Home Page Logon

- Go to "Help" of menu bar → "About" to check MSCS & MPDP Firmware version.



Checking MSCS & MPDP Firmware Version

6. MSCS Protocol

1. Comport Configuration

1. Baudrate : 115200
2. Data Bits : 8
3. Parity : None
4. Stop Bits : 1
5. Flow Control : None

2. Protocol Form

• Send To PDP

Command	PDP ID	Sub Command	Data	End
4byte	2byte	4byte	Variable	1byte

• Receive From PDP

Command	PDP ID	Sub Command	Data	End
4byte	2byte	4byte	Variable	1byte

3. Protocol Value

3.1 Command

• Send To PDP

Send To PDP (Send Data)	Char	k(0x6B)	M(0x4D)
	Hex	0x36 0x3B	0x34 0x3D

• Receive From PDP

Receive From PDP (Response Data)	Char	k(0x6B)	N(0x4E)
	Hex	0x36 0x3B	0x34 0x3E

3.2 PDP ID

2byte : ID[1](high byte) + ID[0](low byte)
 Ex) PDP ID => ID[1] = ((PDP ID)&0xF0>>4) + 0x30; //high byte
 ID[0] = (PDP ID & 0x0F) + 0x30; //low byte

2byte of Broadcast On Command : ID[1](high byte) + ID[0] (low byte)
 Ex) PDP ID => ID[1] = 0x3F;
 //high byte
 ID[0] = 0x3E; //low byte

3.3 Sub Command

• Power Command

Power On	Char	R(0x52)	n(0x6E)
	Hex	0x35 0x32	0x36 0x3E

Power Off	Char	R(0x52)	f(0x66)
	Hex	0x35 0x32	0x36 0x36

• Auto Power Command

Auto Power On	Char	R(0x52)	M(0x4D)
	Hex	0x35 0x32	0x34 0x3D

Auto Power Off	Char	R(0x52)	m(0x6D)
	Hex	0x35 0x32	0x36 0x3D

• Multi Scale Command

Multi Scale	Char	M(0x4D)	s(0x73)
	Hex	0x34 0x3D	0x37 0x33

• Tracking Command

Tracking Auto	Char	R(0x52)	a(0x61)
	Hex	0x35 0x32	0x36 0x31

Tracking Manual Frequency	Char	R(0x52)	F(0x46)
	Hex	0x35 0x32	0x34 0x36

Tracking Manual Phase	Char	R(0x52)	P(0x50)
	Hex	0x35 0x32	0x35 0x30

Tracking Manual Line Start	Char	R(0x52)	L(0x4C)
	Hex	0x35 0x32	0x34 0x3C

Tracking Manual Pixel Start	Char	R(0x52)	X(0x58)
	Hex	0x35 0x32	0x35 0x38

• Test Pattern Command

Test Pattern Red	Char	R(0x52)	5(0x35)
	Hex	0x35 0x32	0x33 0x35

Test Pattern Green	Char	R(0x52)	6(0x36)
	Hex	0x35 0x32	0x33 0x36

Test Pattern Blue	Char	R(0x52)	7(0x37)
	Hex	0x35 0x32	0x33 0x37

Test Pattern White	Char	R(0x52)	8(0x38)
	Hex	0x35 0x32	0x33 0x38

Test Pattern Screen	Char	R(0x52)	9(0x39)
	Hex	0x35 0x32	0x33 0x39

• SoftWare Reset Command

SoftWare Reset Master	Char	R(0x52)	R(0x52)
	Hex	0x35 0x32	0x35 0x32

SoftWare Reset Slave	Char	R(0x52)	R(0x72)
	Hex	0x35 0x32	0x37 0x32

• APL Command

APL On	Char	R(0x52)	x(0x78)
	Hex	0x35 0x32	0x37 0x38

APL Off	Char	R(0x52)	y(0x79)
	Hex	0x35 0x32	0x37 0x39

• Shut Down Command

Shut Down Disable	Char	R(0x52)	S(0x53)
	Hex	0x35 0x32	0x35 0x33

Shut Down Master Enable	Char	R(0x52)	H(0x48)
	Hex	0x35 0x32	0x34 0x38

Shut Down Slave Enable	Char	R(0x52)	h(0x68)
	Hex	0x35 0x32	0x36 0x38

• Picture Control Graphic User Mode Command

User Mode Graphic - Brightness	Char	G(0x47)	a(0x61)
	Hex	0x34 0x37	0x36 0x31

User Mode Graphic - Contrast	Char	G(0x47)	b(0x62)
	Hex	0x34 0x37	0x36 0x32

User Mode Graphic - Sharpness	Char	G(0x47)	c(0x63)
	Hex	0x34 0x37	0x36 0x33

User Mode Graphic - Color	Char	G(0x47)	d(0x64)
	Hex	0x34 0x37	0x36 0x34

User Mode Graphic - Tint	Char	G(0x47)	e(0x65)
	Hex	0x34 0x37	0x36 0x35

• Picture Control White Balance Command

White Balance Gain R	Char	G(0x47)	A(0x41)
	Hex	0x34 0x37	0x34 0x31

White Balance Gain G	Char	G(0x47)	B(0x42)
	Hex	0x34 0x37	0x34 0x32

White Balance Gain B	Char	G(0x47)	C(0x43)
	Hex	0x34 0x37	0x34 0x33

White Balance Offset R	Char	G(0x47)	D(0x44)
	Hex	0x34 0x37	0x34 0x34

White Balance Offset G	Char	G(0x47)	E(0x45)
	Hex	0x34 0x37	0x34 0x35

White Balance Offset B	Char	G(0x47)	F(0x46)
	Hex	0x34 0x37	0x34 0x36

• Picture Control Graphic Data Command

Graphic Data Gain R	Char	G(0x47)	r(0x72)
	Hex	0x34 0x37	0x37 0x32

Graphic Data Gain G	Char	G(0x47)	s(0x73)
	Hex	0x34 0x37	0x37 0x33

Graphic Data Gain B	Char	G(0x47)	t(0x74)
	Hex	0x34 0x37	0x37 0x34

Graphic Data Offset R	Char	G(0x47)	u(0x75)
	Hex	0x34 0x37	0x37 0x35

Graphic Data Offset G	Char	G(0x47)	v(0x76)
	Hex	0x34 0x37	0x37 0x36

Graphic Data Offset B	Char	G(0x47)	w(0x77)
	Hex	0x34 0x37	0x37 0x37

• Picture Control Video Data Command

Video Data Luminance Brightness	Char	V(0x56)	r(0x72)
	Hex	0x35 0x36	0x37 0x32

Video Data Luminance Contrast	Char	V(0x56)	s(0x73)
	Hex	0x35 0x36	0x37 0x33

Video Data Cr	Char	V(0x56)	t(0x74)
	Hex	0x35 0x36	0x37 0x34

Video Data Cb	Char	V(0x56)	u(0x75)
	Hex	0x35 0x36	0x37 0x35

Video Data Color	Char	V(0x56)	v(0x76)
	Hex	0x35 0x36	0x37 0x36

Video Data Tint	Char	V(0x56)	w(0x77)
	Hex	0x35 0x36	0x37 0x37

• Get Data Command

Get Data Tracking Manual	Char	R(0x52)	A(0x41)
	Hex	0x35 0x32	0x34 0x31

Get Data Total Data	Char	G(0x47)	T(0x54)
	Hex	0x35 0x32	0x35 0x34

• OSD Info Command

OSD Info	Char	R(0x52)	l(0x49)
	Hex	0x35 0x32	0x34 0x39

3.4 Data

• Send Data : Multi Scale Data

Multi Scale	Char	S(Source)		M(Width)		N(Height)		P(Position)	
	Hex	High Value	Low Value	High Value	Low Value	High Value	Low Value	High Value	Low Value

• Send Data : Multi Scal Data -> Source

DVI	Char	i(0x69)	
	Hex	0x36	0x39
PC	Char	p(0x70)	
	Hex	0x37	0x30
DTV	Char	t(0x74)	
	Hex	0x37	0x34
DVD	Char	d(0x64)	
	Hex	0x36	0x34
S-VIDEO	Char	s(0x73)	
	Hex	0x37	0x33
VIDEO	Char	v(0x76)	
	Hex	0x37	0x36

• Send Data : Test Pattern Red, Green, Blue Data

Test Pattern Data	Char	Value	
	Hex	High Value	Low Value

• Send Data : Picture Control Graphic & Video Data

Graphic Data, Video Data	Char	Value	
	Hex	High Value	Low Value

• Receive Data : Tracking Manual Data

Receive Data : 8byte	Data[0]	Frequency High Value
	Data[1]	Frequency Low Value
	Data[2]	Phase High Value
	Data[3]	Phase Low Value
	Data[4]	Line Start High Value
	Data[5]	Line Start Low Value
	Data[6]	Pixel Start High Value
	Data[7]	Pixel Start Low Value

• Receive Data : Picture Control User Mode Data

Receive Data : 10byte	Data[0]	Brightness High Value
	Data[1]	Brightness Low Value
	Data[2]	Contrast High Value
	Data[3]	Contrast Low Value
	Data[4]	Sharpness High Value
	Data[5]	Sharpness Low Value
	Data[6]	Saturation High Value
	Data[7]	Saturation Low Value
	Data[8]	Hue High Value
	Data[9]	Hue Low Value

• Receive Data : Picture Control White Balance Control Data

Receive Data : 12byte	Data[10]	LUT Gain Red High Value
	Data[11]	LUT Gain Red Low Value
	Data[12]	LUT Gain Green High Value
	Data[13]	LUT Gain Green Low Value
	Data[14]	LUT Gain Blue High Value
	Data[15]	LUT Gain Blue Low Value
	Data[16]	LUT Offset Red High Value
	Data[17]	LUT Offset Red Low Value
	Data[18]	LUT Offset Green High Value
	Data[19]	LUT Offset Green Low Value
	Data[20]	LUT Offset Blue High Value
	Data[21]	LUT Offset Blue Low Value

• Receive Data : Picture Control Graphic or Video Data

Receive Data : 12byte	Data[22]	Data 1 High Value
	Data[23]	Data 1 Low Value
	Data[24]	Data 2 High Value
	Data[25]	Data 2 Low Value
	Data[26]	Data 3 High Value
	Data[27]	Data 3 Low Value
	Data[28]	Data 4 High Value
	Data[29]	Data 4 Low Value
	Data[30]	Data 5 High Value
	Data[31]	Data 5 Low Value
	Data[32]	Data 6 High Value
	Data[33]	Data 6 Low Value

3.5 End

• End(1byte)

End	0x0d
-----	------

※ Attachment : ASCII to HEX Conversion Table

ASCII	HEX	ASCII	HEX	ASCII	HEX	ASCII	HEX	ASCII	HEX	ASCII	HEX	ASCII	HEX
Esc	1B	,	2C	;	3B	J	4A	Y	59	h	68	w	77
CR	0D	-	2D	<	3C	K	4B	Z	5A	i	69	x	78
LF	0A	.	2E	=	3D	L	4C	[5B	j	6A	y	79
Space	20	/	2F	>	3E	M	4D	\	5C	k	6B	z	7A
!	21	0	30	?	3F	N	4E]	5D	l	6C	{	7B
"	22	1	31	@	40	O	4F	^	5E	m	6D		7C
#	23	2	32	A	41	P	50	-	5F	n	6E	}	7D
\$	24	3	33	B	42	Q	51	`	60	o	6F	~	7E
%	25	4	34	C	43	R	52	a	61	p	70	DEL	7F
&	26	5	35	D	44	S	53	b	62	q	71		
'	27	6	36	E	45	T	54	c	63	r	72		
(28	7	37	F	46	U	55	d	64	s	73		
)	29	8	38	G	47	V	56	e	65	t	74		
*	2A	9	39	H	48	W	57	f	66	u	75		
+	2B	:	3A	I	49	X	58	g	67	v	76		

7. Other tips

7.1. Before calling for service

Before calling for any repair, check the following and then refer to a near A/S center.

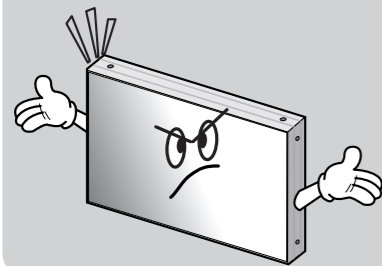

► "Tick" sound from the main body.

- If there is no problem with the screen or sound, the "tick" sound is likely to result from the cabinet lightly shrinking with the change of room temperature. The sound does not affect product's performance.

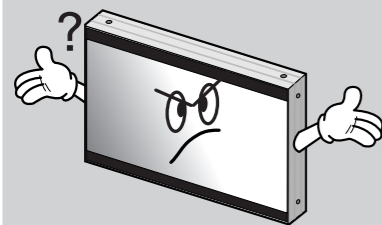

► No image at upper and lower part of the screen.

- As for a screen which is over 16:9 in width (such as cinema-sized one), no image may be displayed at upper and bottom part of the screen.

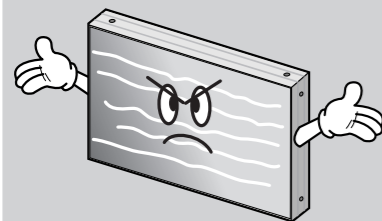

► Speckles or white lines on the screen

- Check whether the problem is caused by vehicle, streetcar, high-voltage cable or neon sign, which emitting interference wave or electromagnetic induction. Avoid any interfering object.

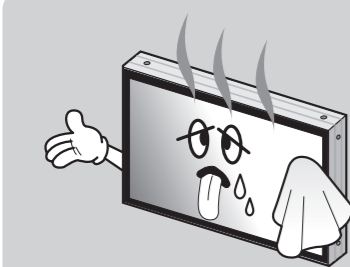

► Screen or a PDP Set is hot

- PDP sets or screen can be hot, because basic principle of PDP driving is Plasma discharge between electrodes.
- It is not a defect or a malfunction of the product, you may continue to use the product.

7.2. About Plasma display panel

The followings are phenomena caused by characteristics of the plasma display panel.

Since it is not a fault, you may continue to use the product.

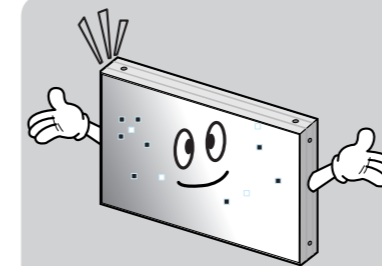

► Black or twinkling spots on the screen

- Although the plasma display panel is manufactured with high-precision technology, there may exist black or twinkling spots on the screen. Since it is not a fault, you may continue to use the product.

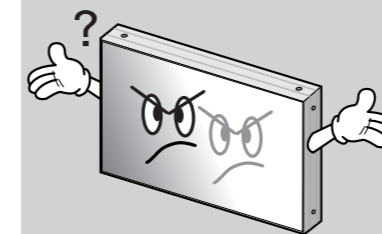

► Afterimage

- When you keep static image still for around 3 hours, an afterimage may occur. However, please always be careful in using still images on this product, because the afterimage may be permanent in some cases.

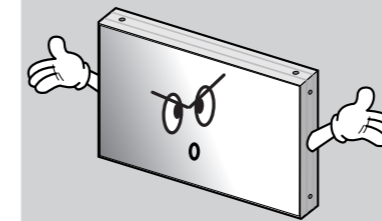

► Noise from the inside

- When you turn on the product slight buzzing sound may be heard from the rear of display panel. Since it is not a fault, you may continue to use the product.

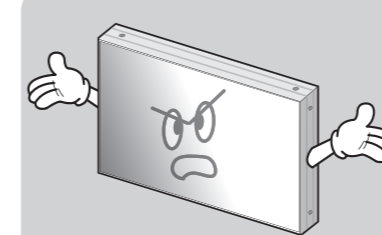

► Screen decolorization

- Optical film that is attached on the panel can be slightly decolorized after long time of use. The degree of decolorization may vary depending on display contents and conditions. It is due to the characteristics of the film, but it is not a defect. (It is caused by chemical characteristics of the film.)

8. Resolution of PC video signal

8.1. DVD / DTV

Input Signal		Resolution	Remarks
DVD	480i	720 x 480	
	480p	720 x 480	
	576i	720 x 576	
	576p	720 x 576	
DTV	720p	1280 x 720	
	1080i	1920 x 1080	

8.2. PC & DVI

- When you select "PC & DVI" for input source, it does not support DTV signal.

Resolution	V-Freq. (Hz)	H-Freq. (KHz)	Remarks
800 x 600	60	37.88	VESA DMT
853 x 480	60	31.50	
1024 x 768	60	48.36	
1280 x 768	60	47.69	VESA CVT
1280 x 960	60	60.00	VESA DMT
1280 x 1024	60	63.97	
1366 x 768	60	47.69	
1600 x 1200	60	75.00	

9. Specifications

Power supply	100 ~ 240V AC. 50/60Hz		
Power consumption	Average (Typical)	300W	
	Max	360W	
Plasma display panel	42 inch, 16:9 Aspect Ratio		
	Contrast ratio	10,000 :1 (Dark Room)	
	Brightness	1,000 cd/m ² (W/O Film)	
Front filter	AGAR (Anti Glare Anti Reflection)		
Number of pixels	853(H) X 480(V)		
Seam gap (In case of multi formation)	4mm		
Environmental condition	Temperature	0° C ~ 35° C	
	Humidity	20% ~ 70%	
Signal	Video signal	NTSC, PAL, SECAM	
	PC signal	SVGA, WVGA, XGA, SXGA, WXGA, UXGA	
	Frequency	Horizontal Frequency 15.5 ~75kHz Vertical Frequency 50/60Hz	
Connectors	Input	Output	
		Same as left side	
	Video		CVBS : BNC 1pin
			S-Video : DIN 4pin
	Component		Y, Pb, Pr : BNC 3pin
	PC		PC RGB : D-Sub 15pin
DVI	TMDS : DVI-D 24pin		
Serial	RS-232C D-Sub 9pin(female)	RS-232C D-Sub 9pin (male)	
External dimension	924.6mm[W] X 521.8mm[H] X75.4mm[D]		
Weight	26kg (±1kg)		

※Product design and specification can be changed for quality improvement without prior notice.

Memo

Memo